

Trousers for Men – AtelierSaison

Please be sure to print in Adobe Acrobat Reader “A4 size” and “Page Sizing & Handling – Custom Scale: 95%”.
Measure straight line below with a ruler to make sure it prints correctly at actual size.
*There may be an error of 0.1 to 0.2 mm depending on the scale.

必ずAdobe Acrobat Readerの「A4サイズ」、「ページサイズ処理—カスタム倍率：95%」で印刷してください。
正しく実寸で印刷されているかどうかを下の直線を定規で図って確認してください。
※縮尺により0.1~0.2mm程度誤差が生じる事があります。

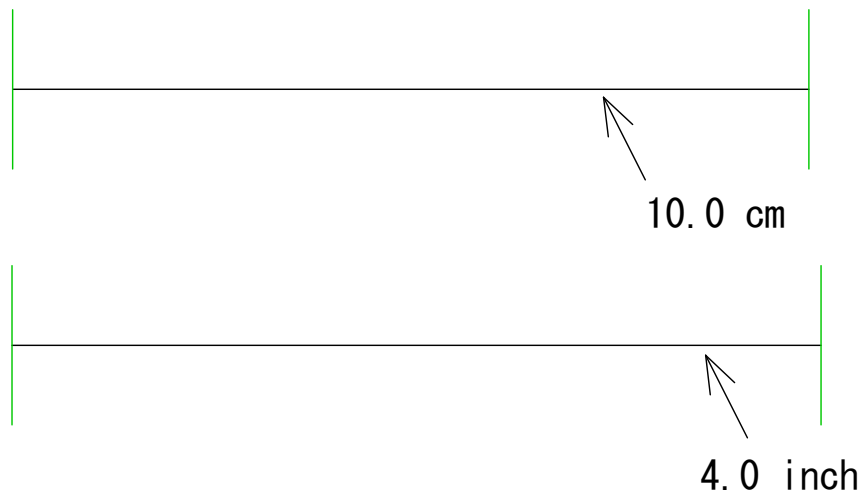
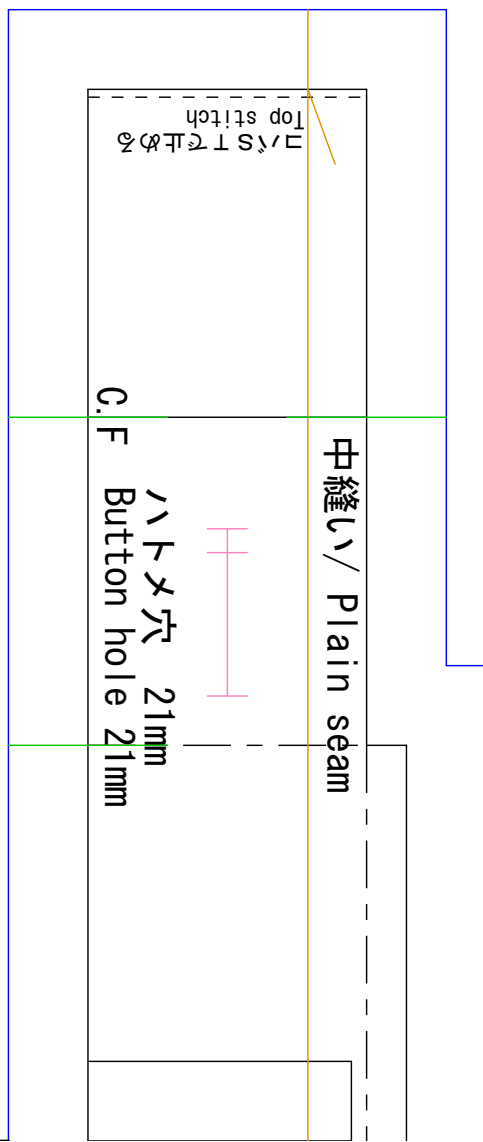

S. A = Seam Allowance
Overlock = Serge seam

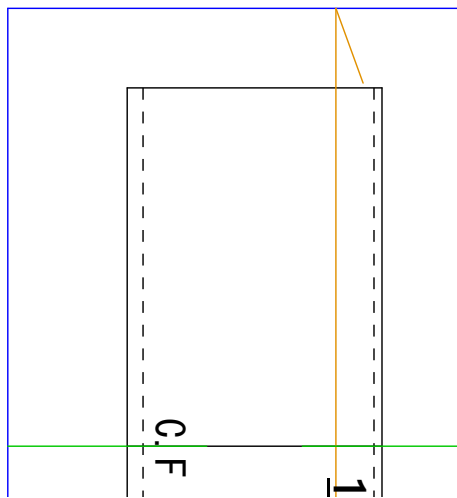

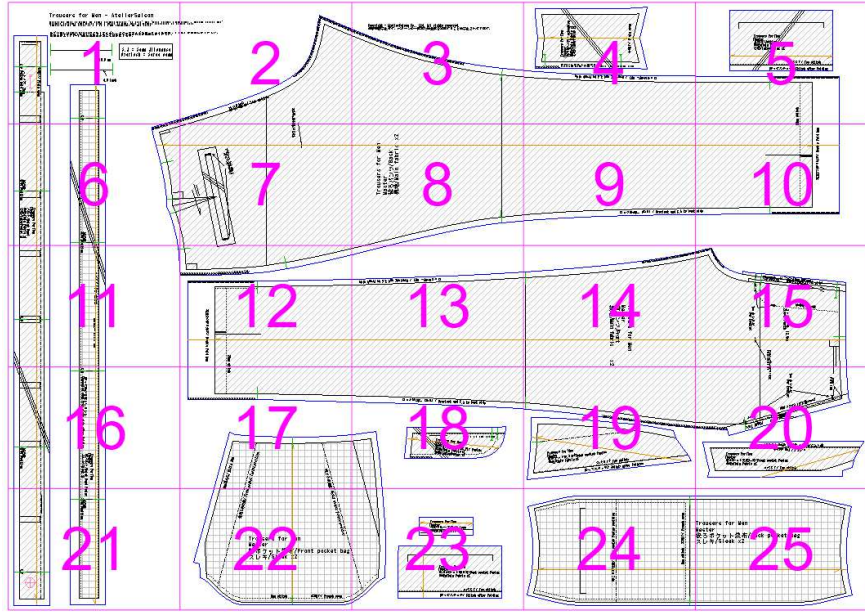

1

2

ロック割り
Over lock and Seam opening

止まり位置
end

2

Copyright © AtelierSaison Co., Ltd. All rights reserved.

無断転載禁止です。パターンの一部または全部を複製することは禁止されています。

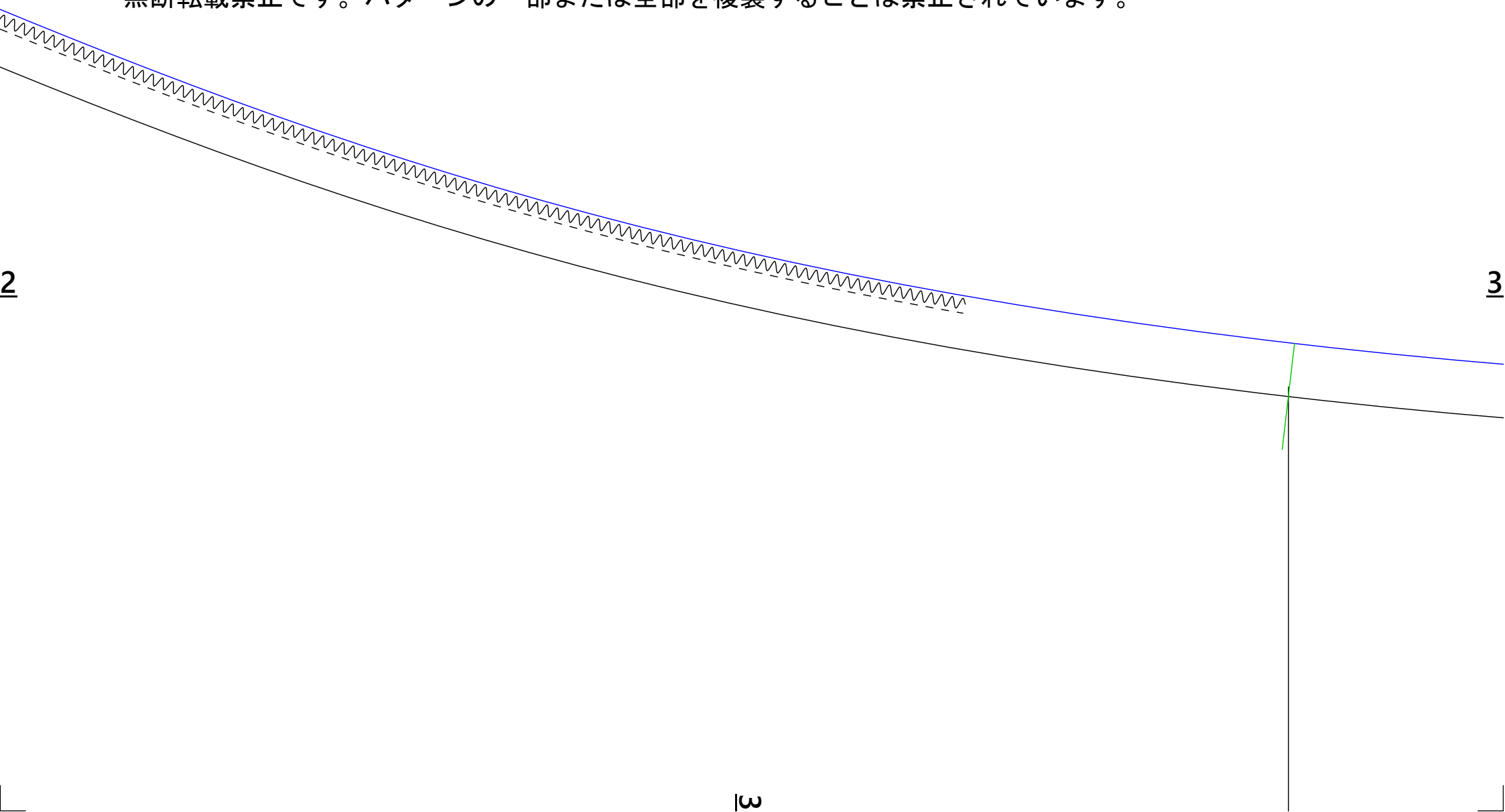

3

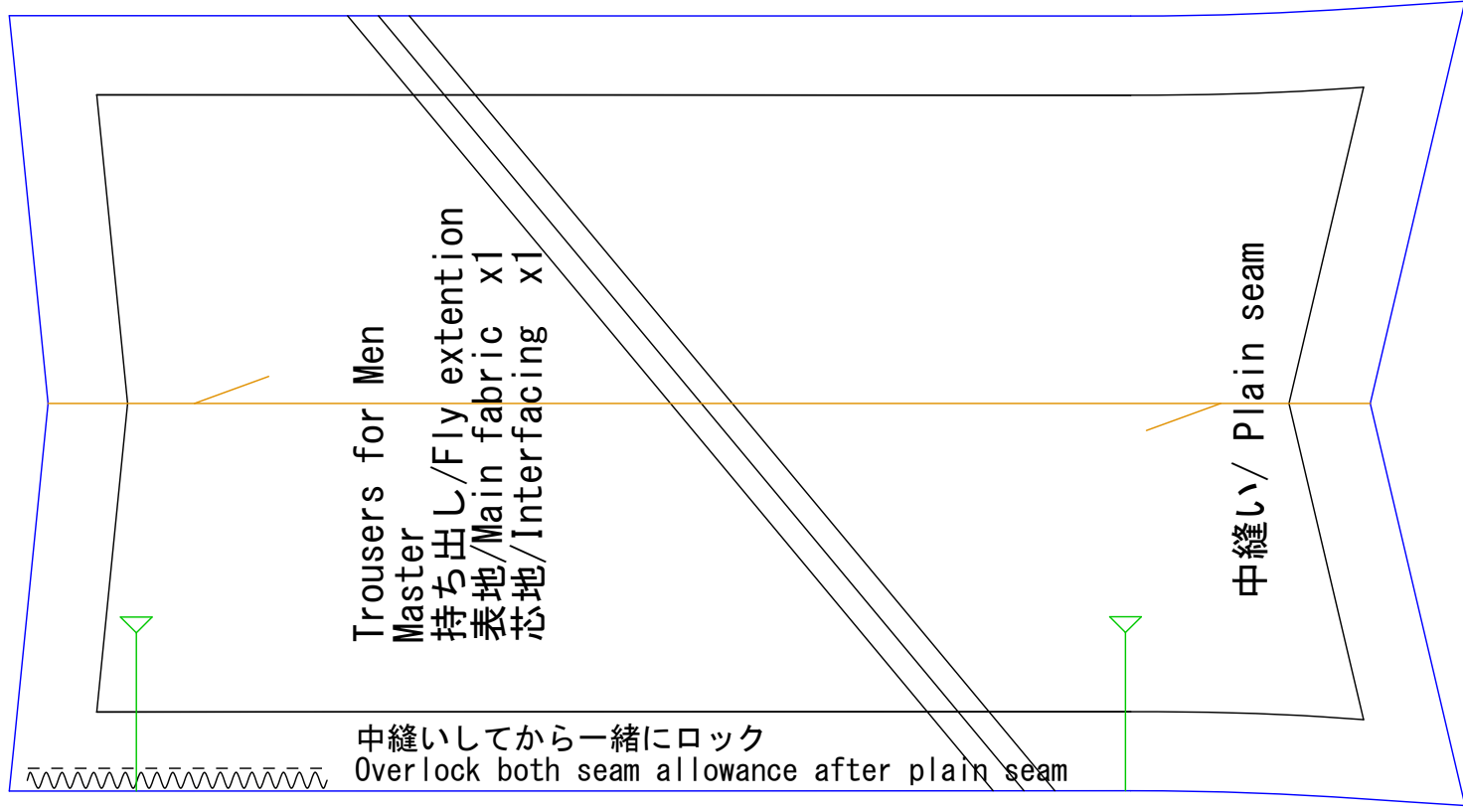

ロック片倒し (前) / Overlock and S. A to front side

4

4

4

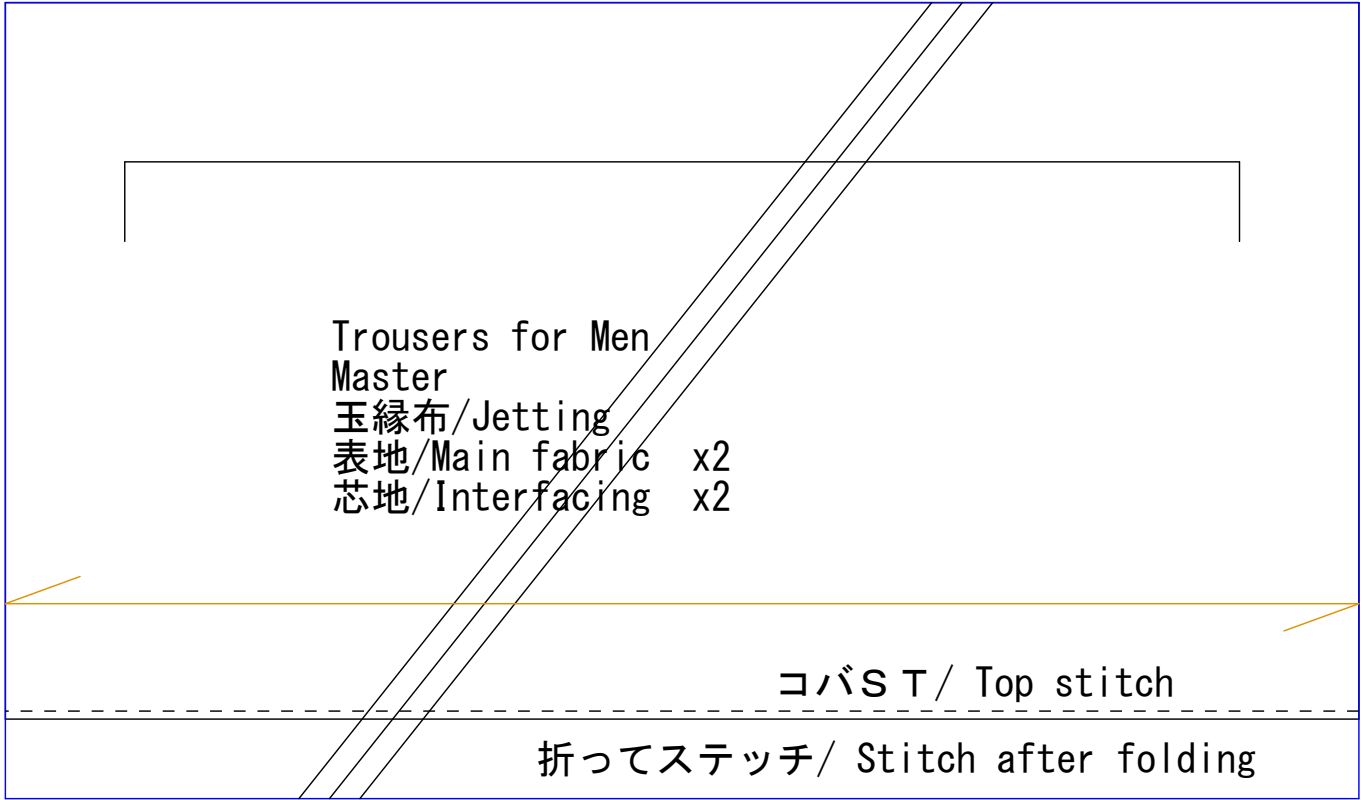

5

mm stitch

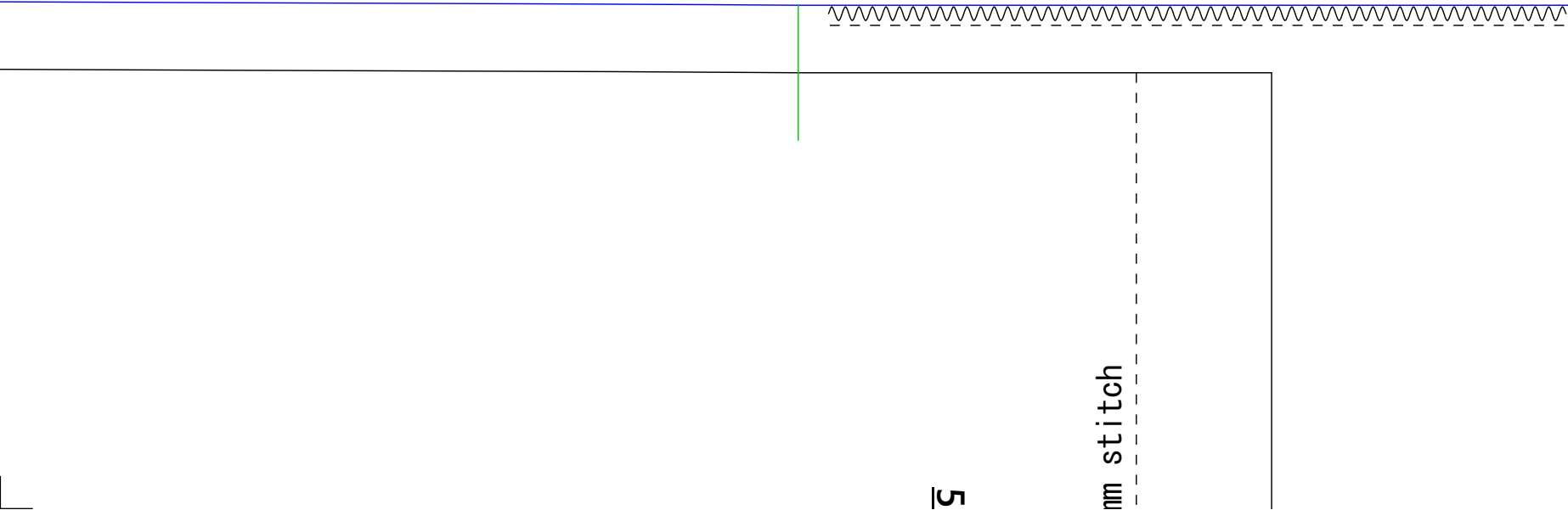

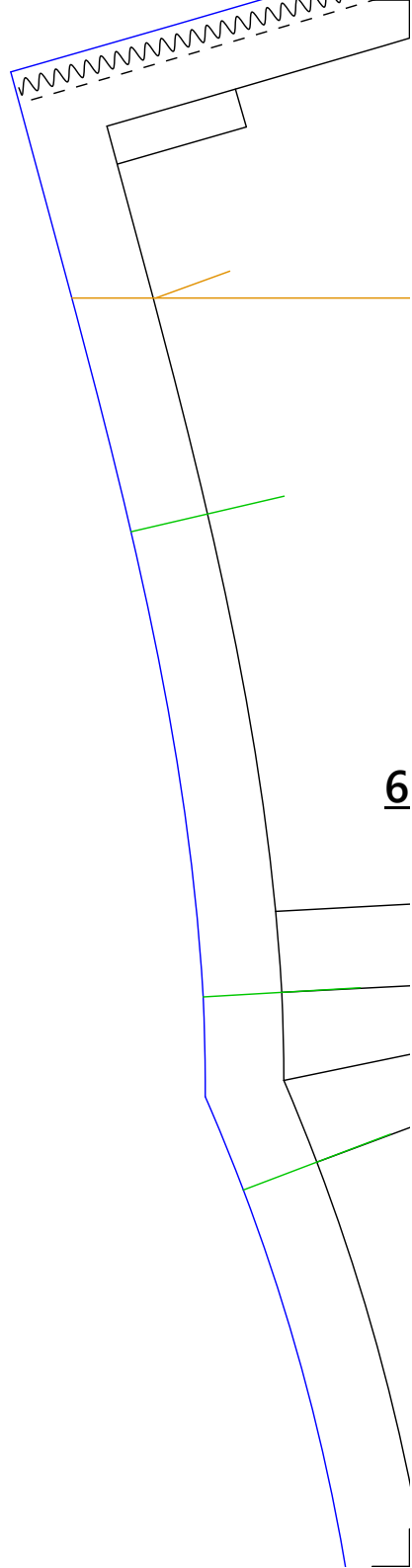

6

6

1

脇位置
Side po

脇位置
Side position

Trousers for Men
Master
ズボン/Waist Band
表地/Main fabric x1
芯地/Interfacing x1

6

ダーツ倒し方向
Dart to side

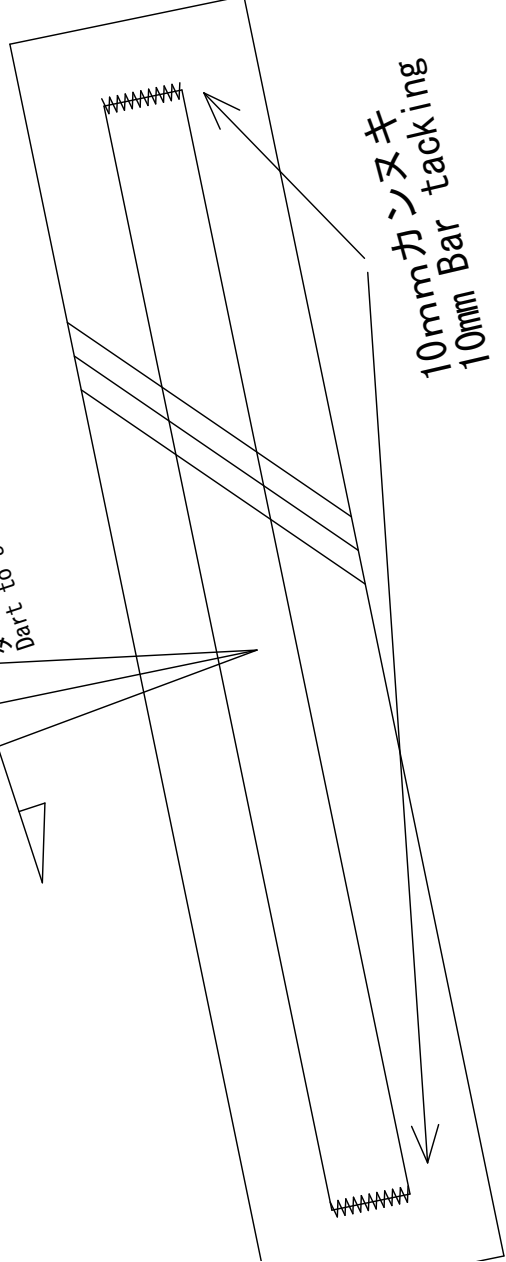

10mmカンヌキ
10mm Bar tacking

7

2

センタープレス
Crease press



7

7

Trousers for Men
Master
後ろパンツ/Back
表地/Main fabric x2

8

3

108

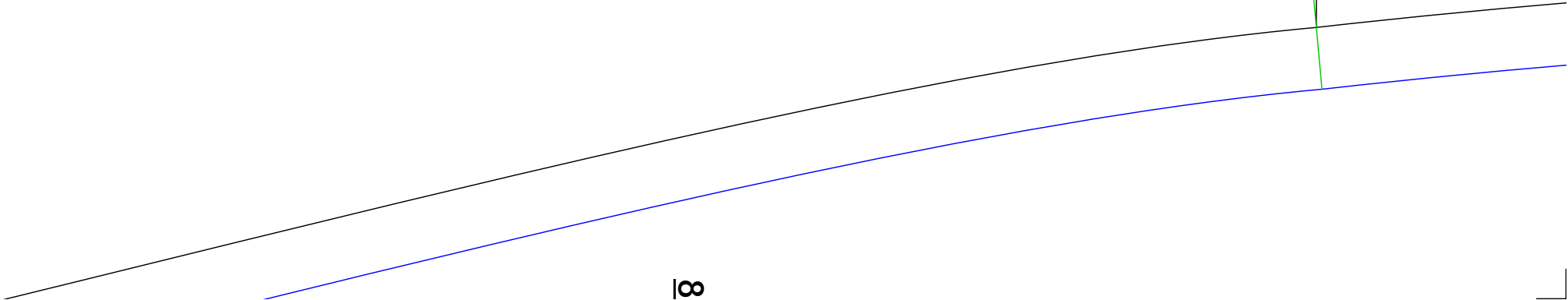

8

4

9

ロック片倒し（後ろ） / Overlock and S.A to back side

9

9

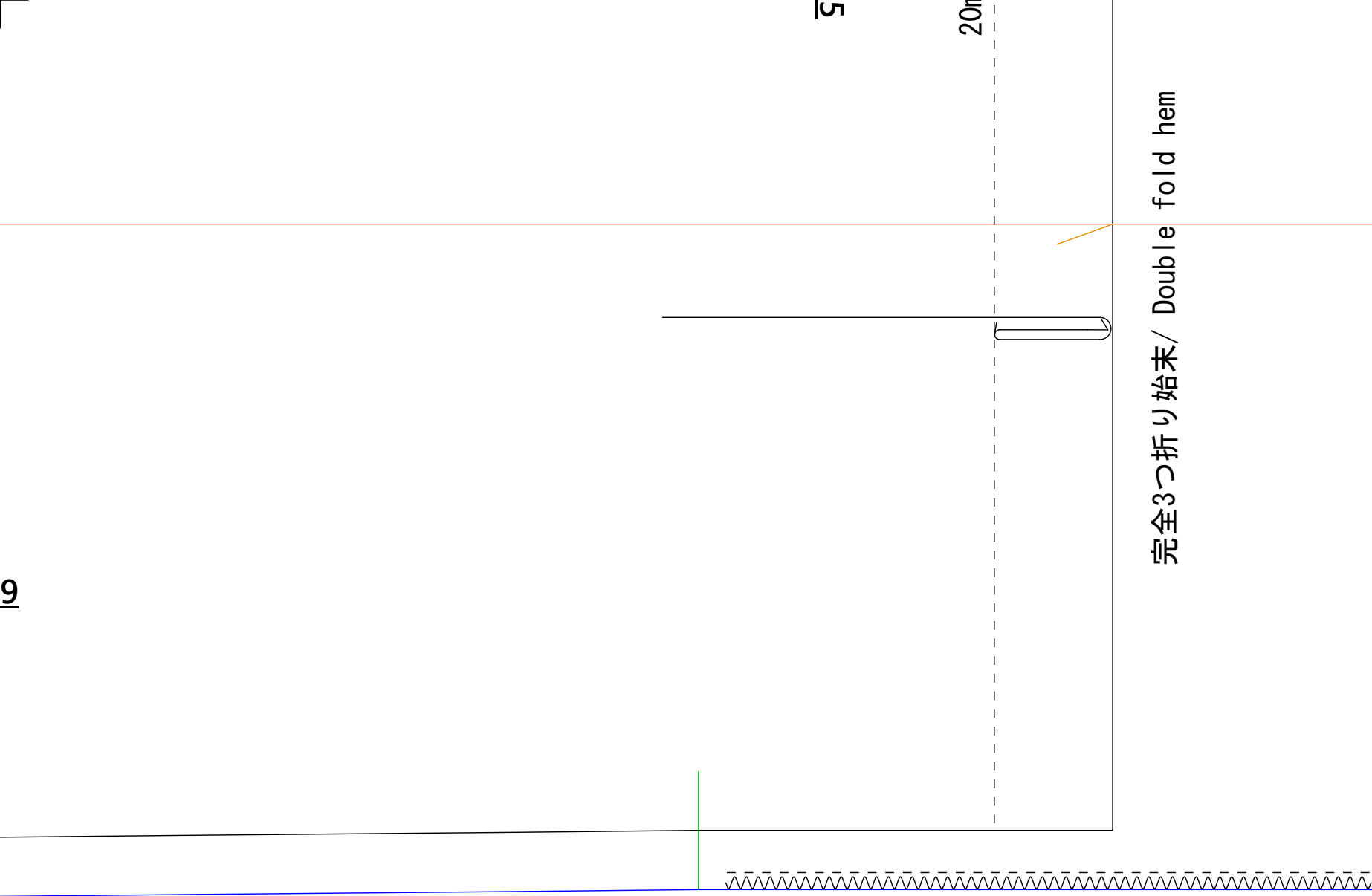

10

6 コ/＼S T / Top stitch

5mm控える / Extra 5mm

11

osition

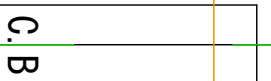

C. B

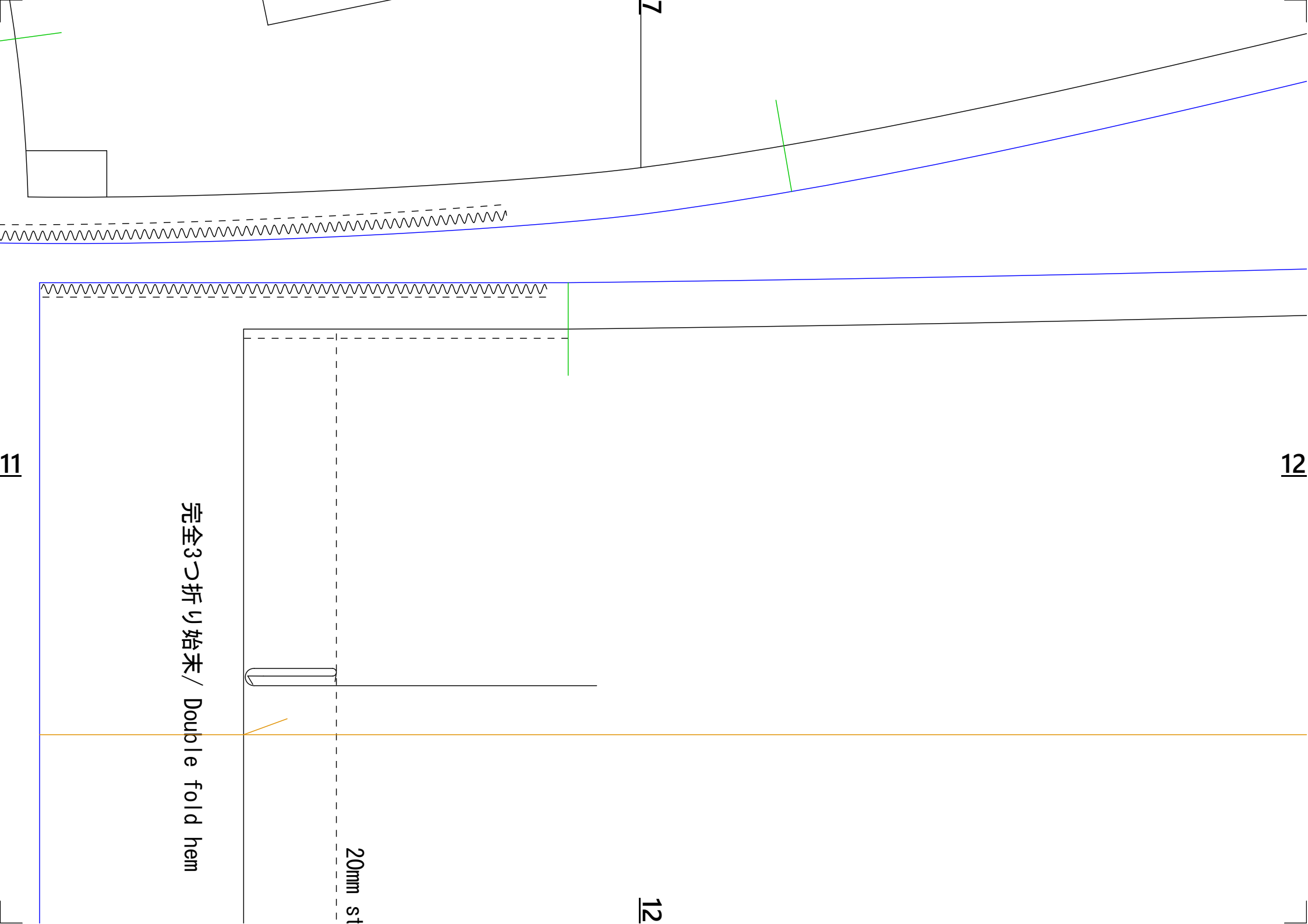

12

12

7

20mm st

完全3つ折り始末 / Double fold hem

111

ロック片倒し (前) / Overlock and S.A to front side

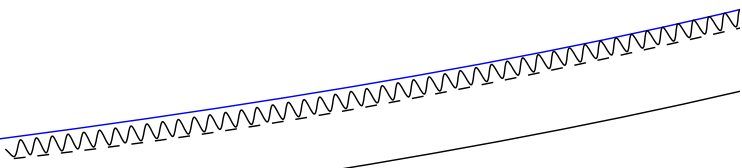

Trousers for Men
Master
前パンツ/Front
表地/Main fabric

型

10

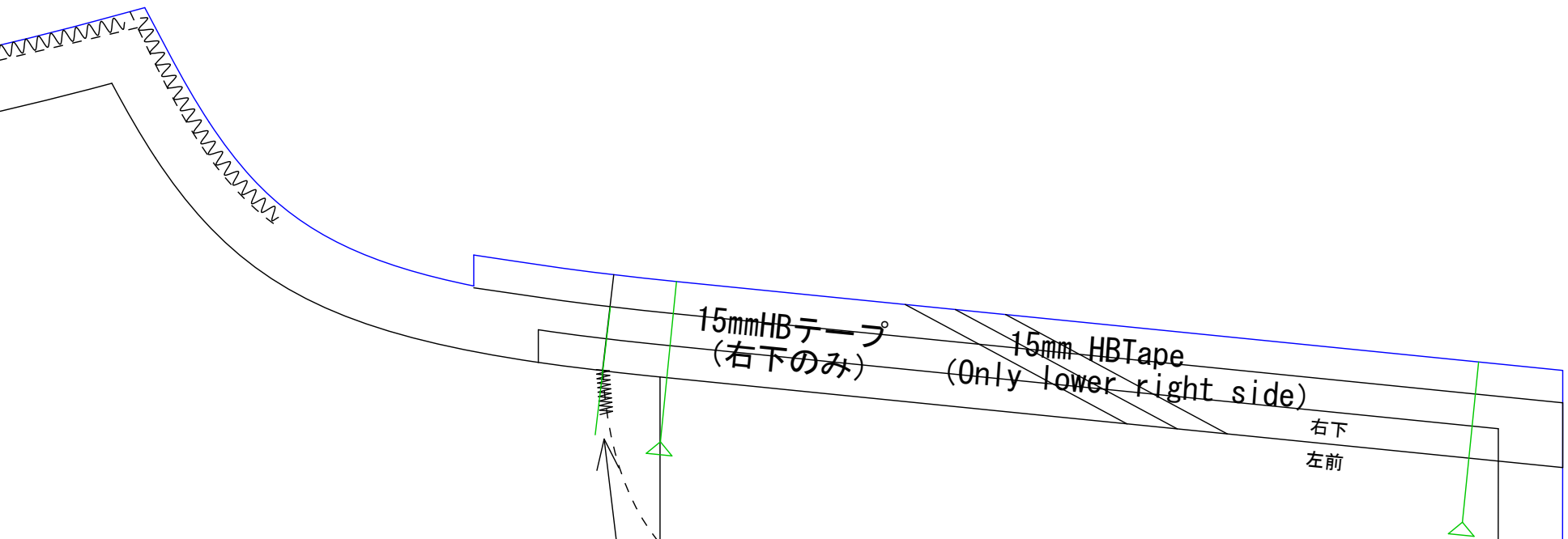

右下
左前

15mmHBテープ
(右下のみ)

15mm HBTape
(Only lower right side)

35mm Stitch

フラスナー長 12.5cm
Zipper length

7mm カンヌキ
Bar tacking

センタープレス
Crease press

ベルト付け落としミシ
Concealed seam under

14

15

11

16

C. B 折って表から落としミシン
Concealed seam from right side after folding

Trousers for Men
Master
裏ベルト/Waist Band F
スレキ/Sleek x1



脇位置
Side position

16

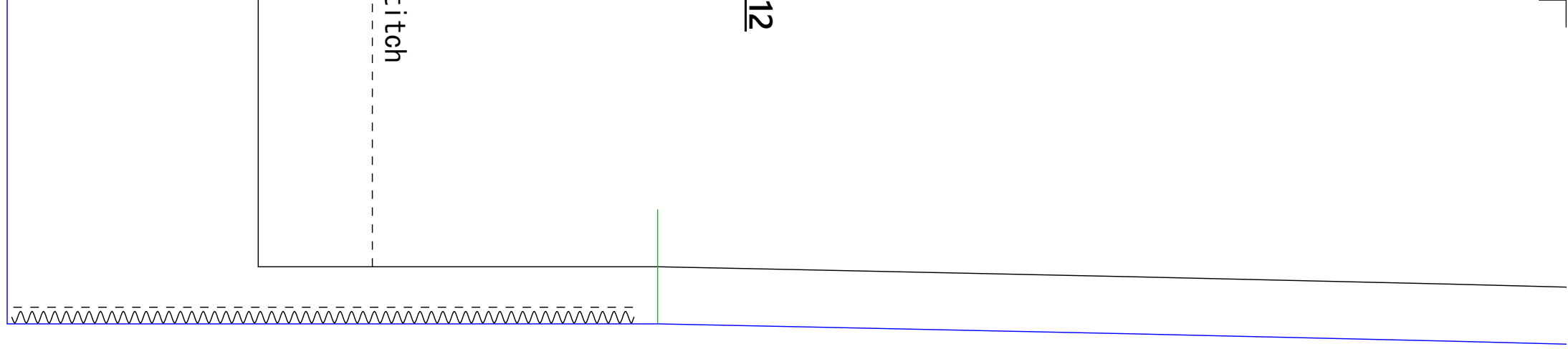

17

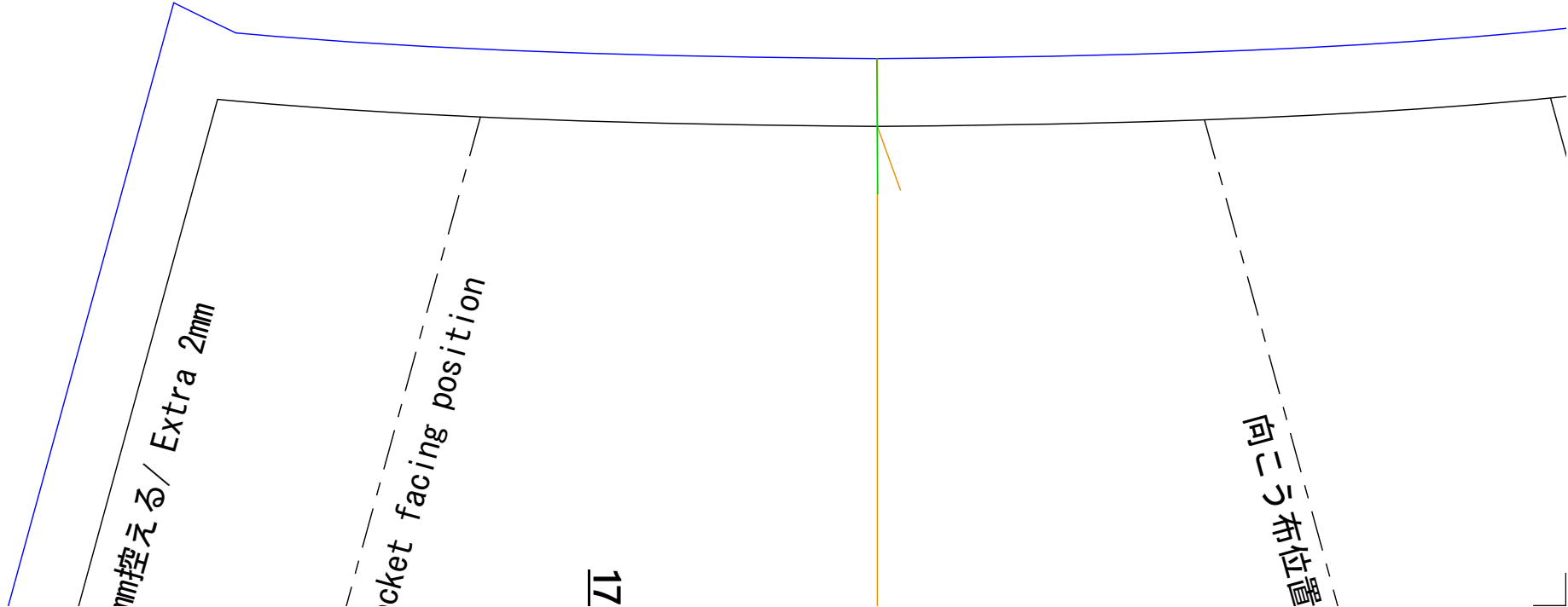

ロック片倒し (後ろ) / Overlock and S.A to back side

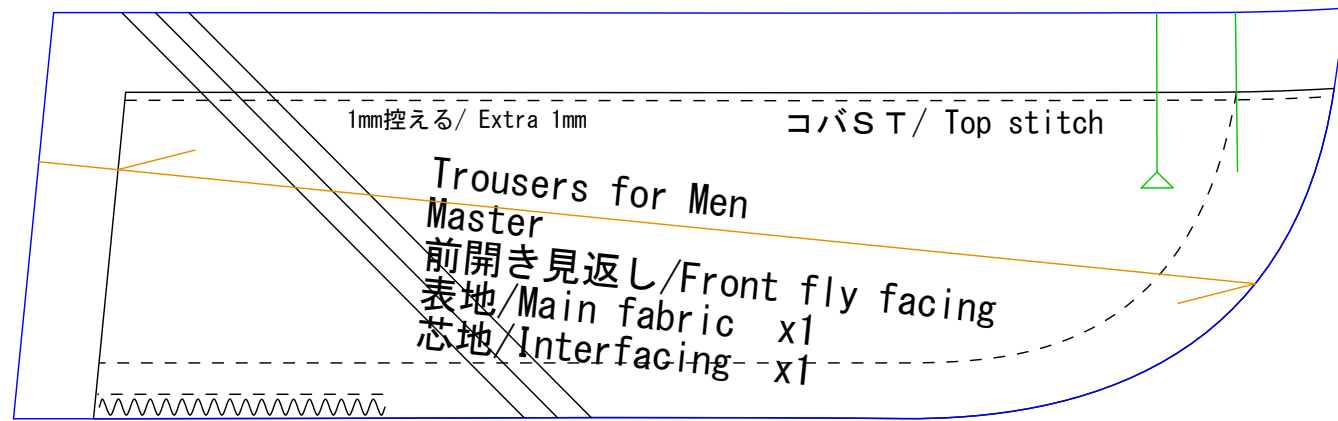

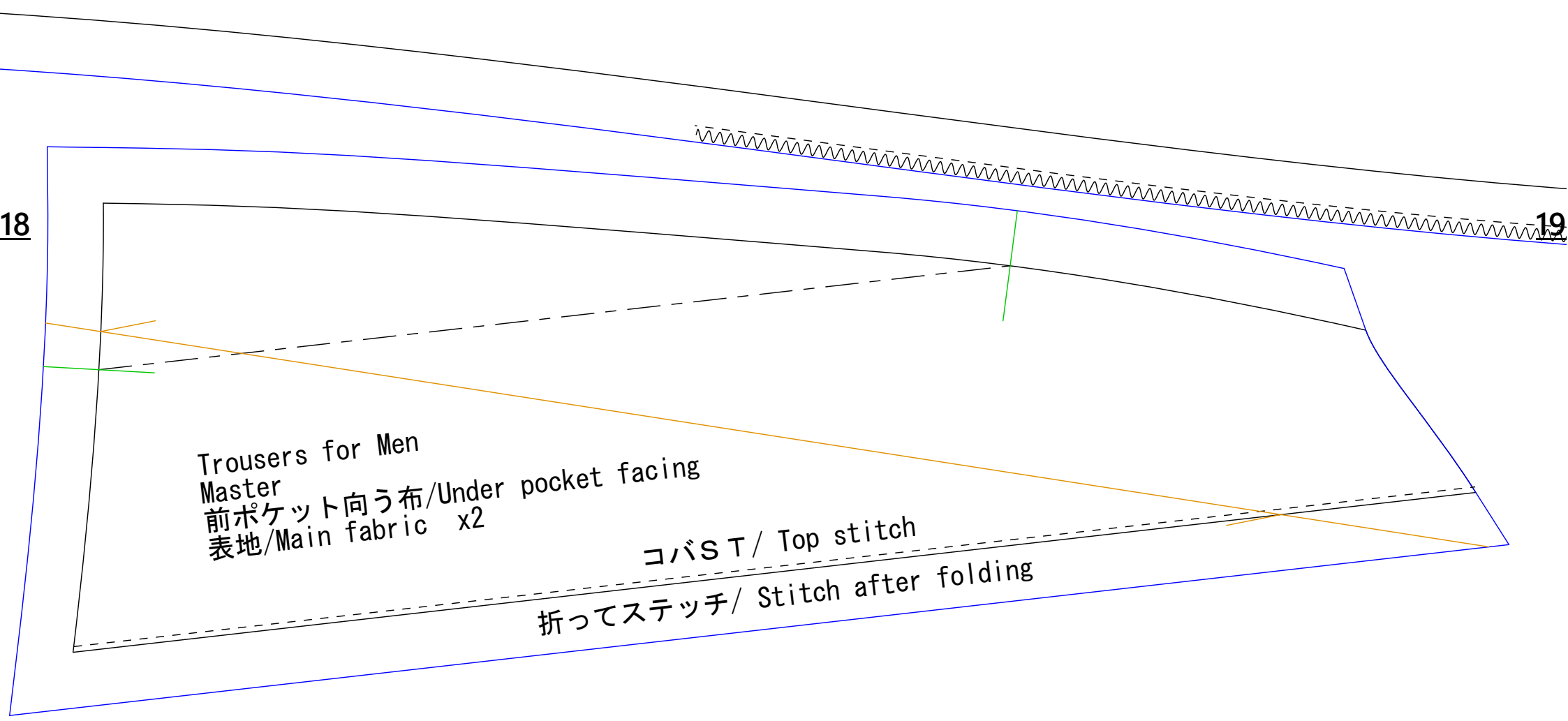

Trousers for Men
 Master
 前ポケット向う布/Under pocket facing
 表地/Main fabric x2

コバST/ Top stitch
 折ってステッチ/ Stitch after folding

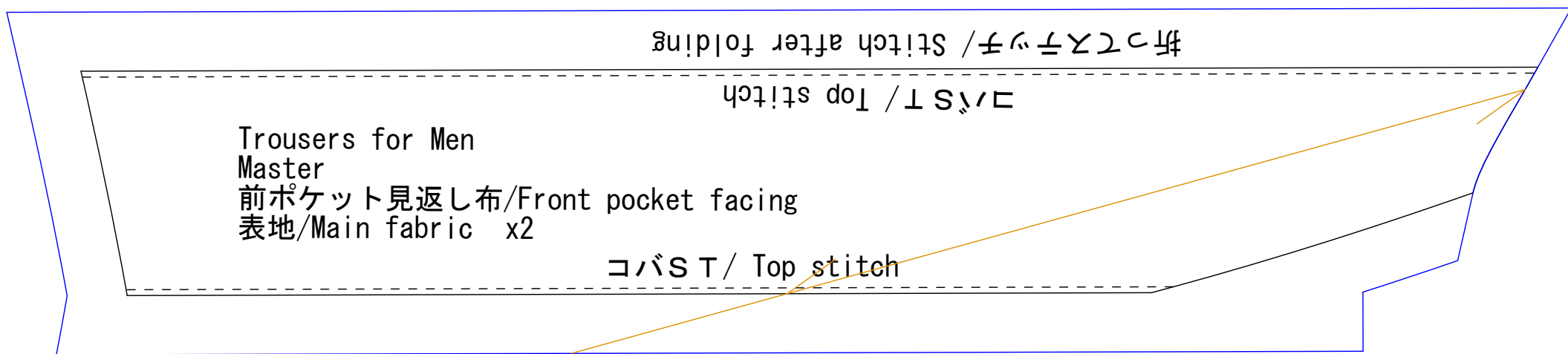
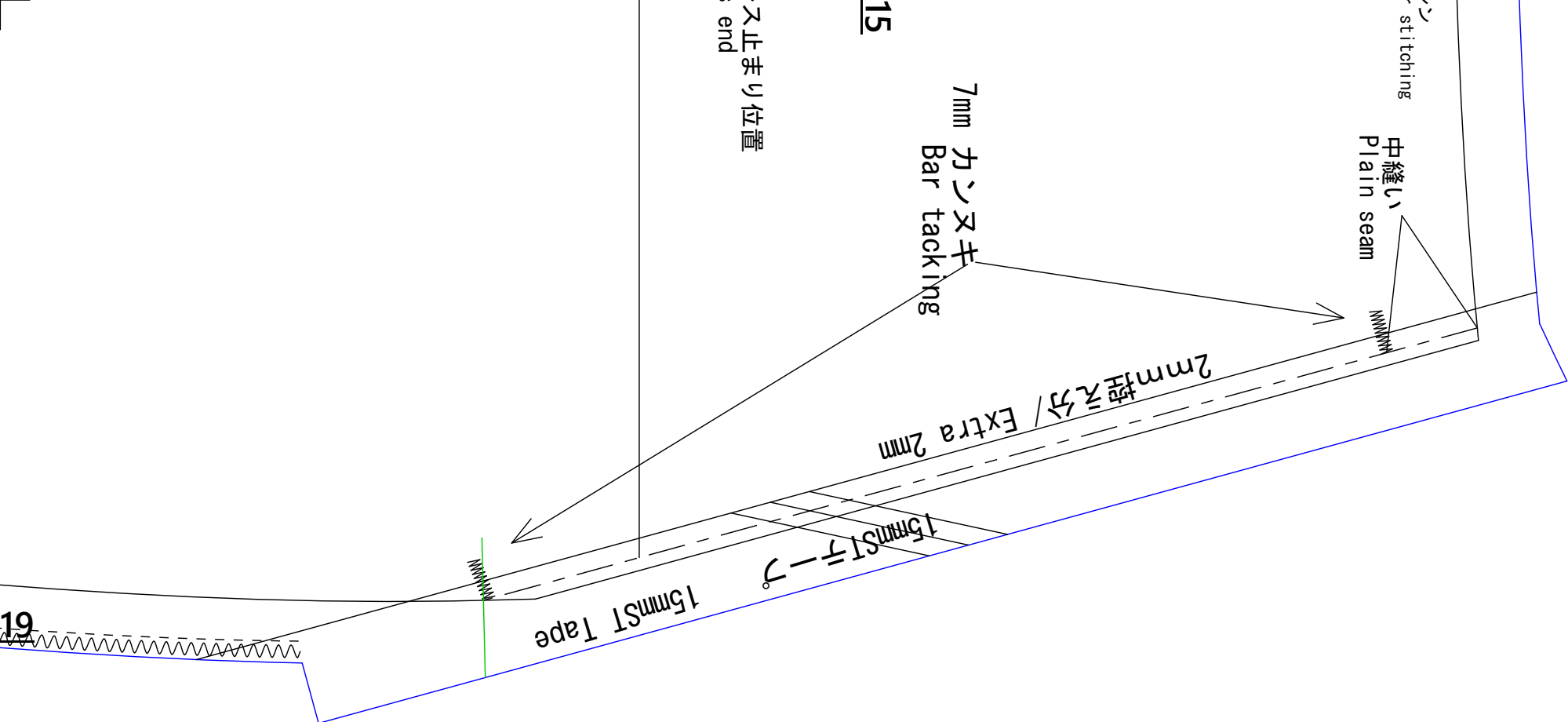

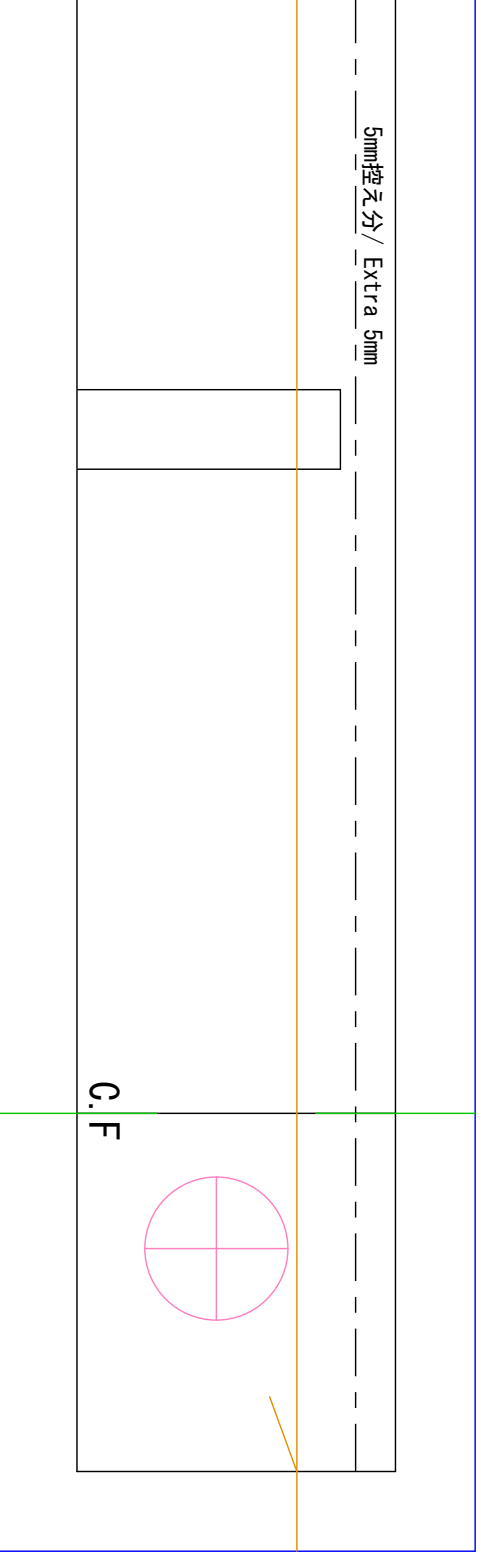
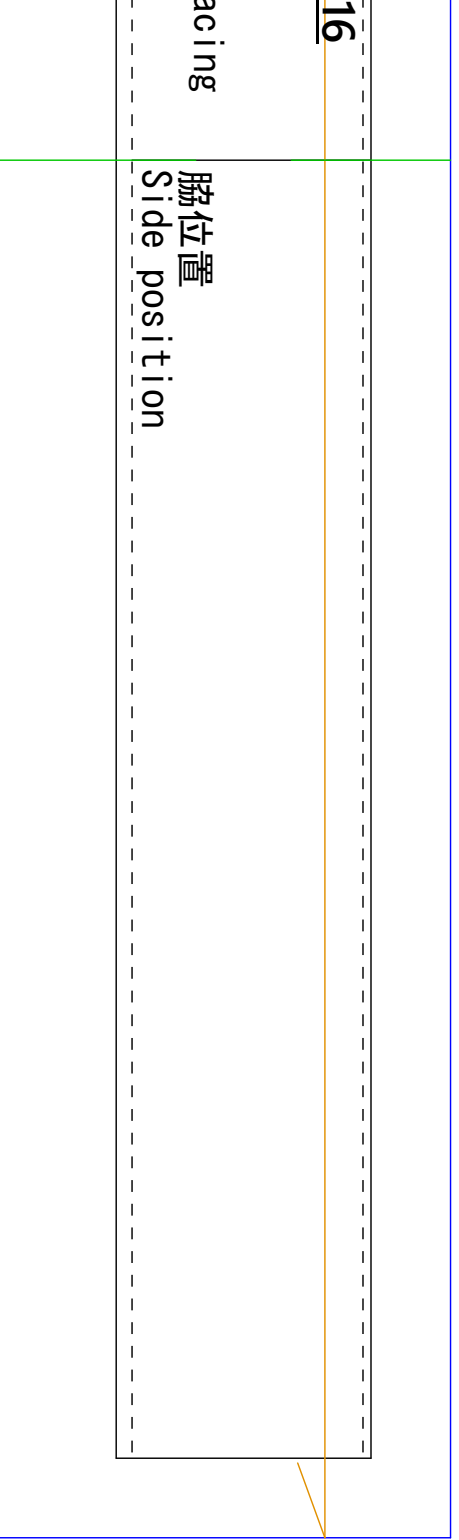

21

21

17

見返し布位置 / Front po

/ Under pocket facing position

Trousers for Men Master

前ポケット袋布 / Front pocket bag
スレキ / Sleek x2

22

6mm stitch

袋縫い / French seam

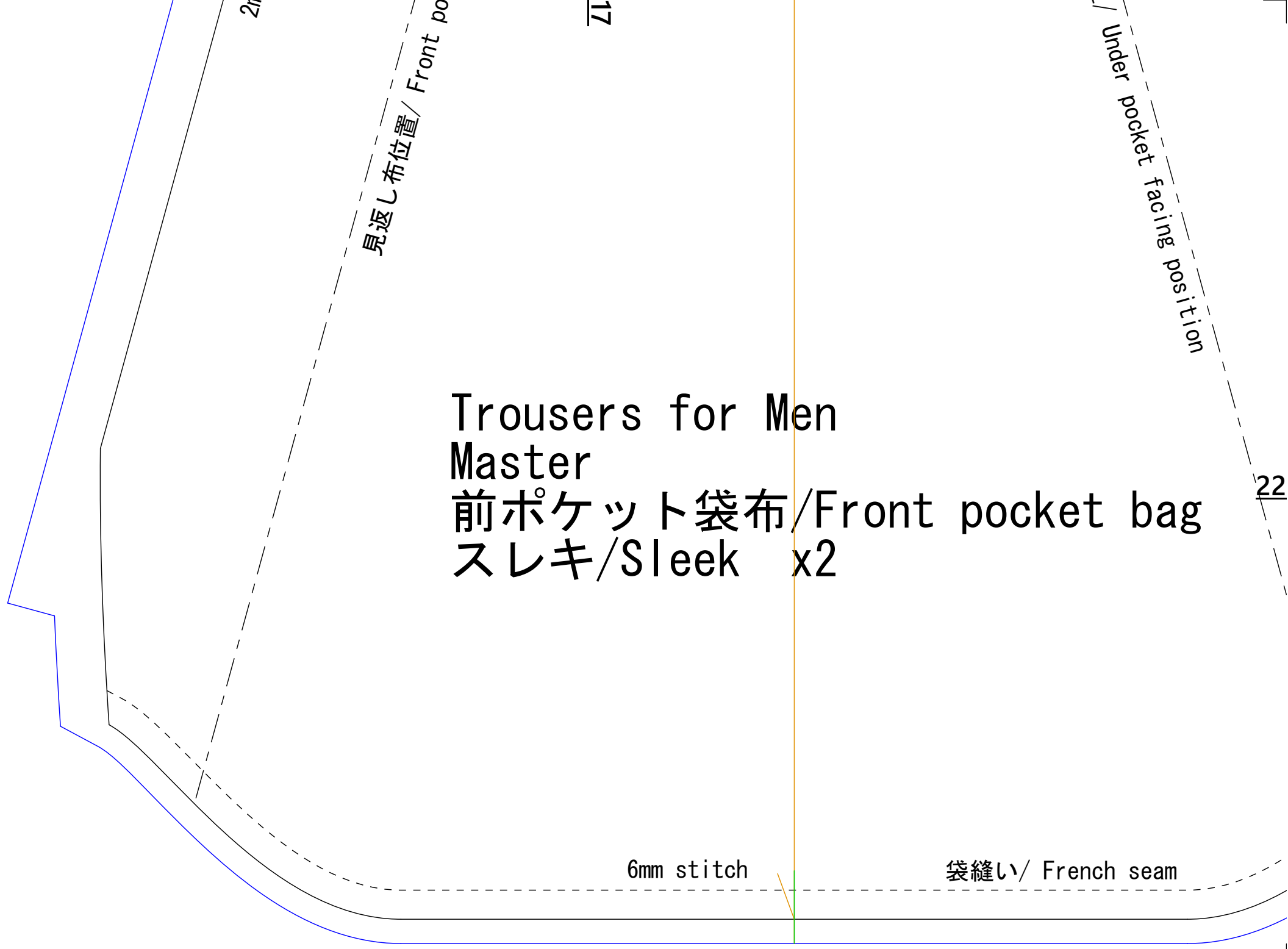

Trousers for Men	
Master	
ベルトループ/Belt loop	
中縫い割り Plain seam and seam opening	表地/Main fabric x7

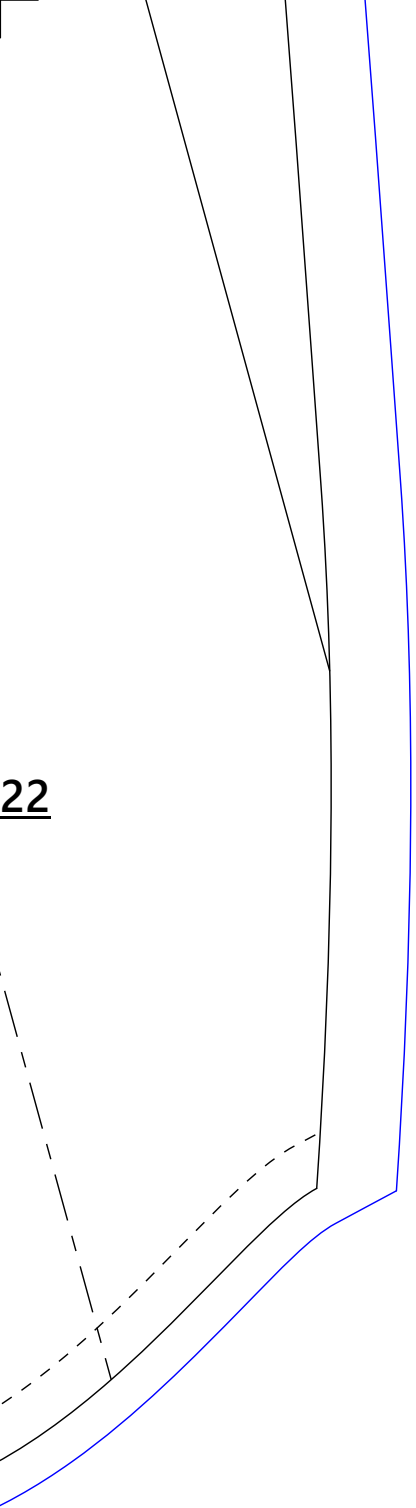

Trousers for Men	
Master	
後ろポケット向う布/Back pocket facing	
表地/Main fabric x2	
コバST / Top stitch	
折ってステッチ / Stitch after folding	

23

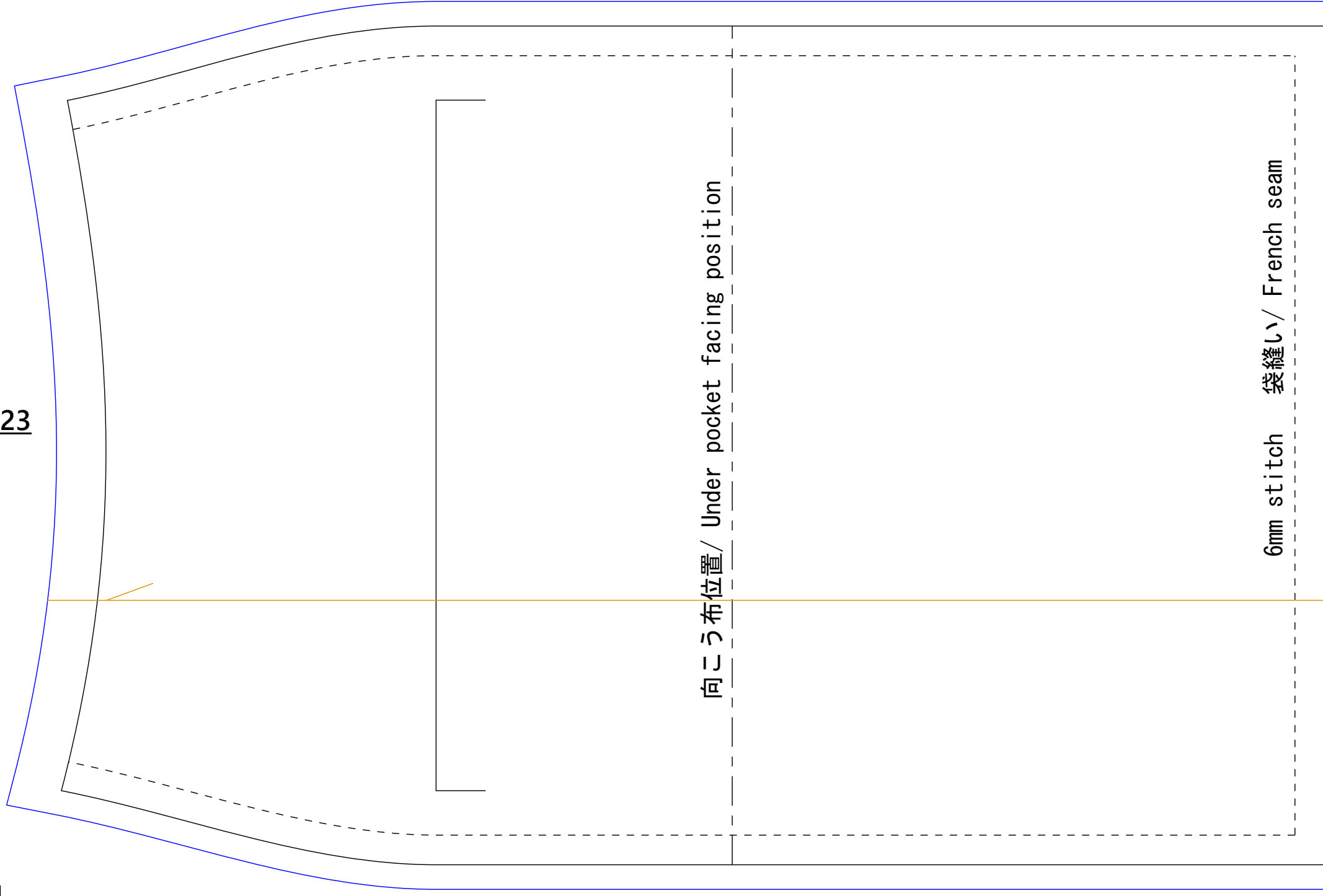

61

向こう布位置 / Under pocket facing position

袋縫い / French seam
6mm stitch

24

Trousers for Men
Master

後ろポケット袋布/Back pocket bag
スレキ/Sleek x2

